



2N7002KCT

N-Channel Enhancement Mode Field Effect Transistor

Product Summary

V_{DS}	60V
I_D	0.3A
$R_{DS(ON)}$ (at $V_{GS}=10V$)	2.5
$R_{DS(ON)}$ (at $V_{GS}=4.5V$)	3



2N7002KCT

Electrical Characteristics ($T_J=25$ unless otherwise noted)

Parameter	Symbol	
-----------	--------	--

--	--	--

--	--	--



2N7002KCT

Typical Electrical and Thermal Characteristics Diagrams

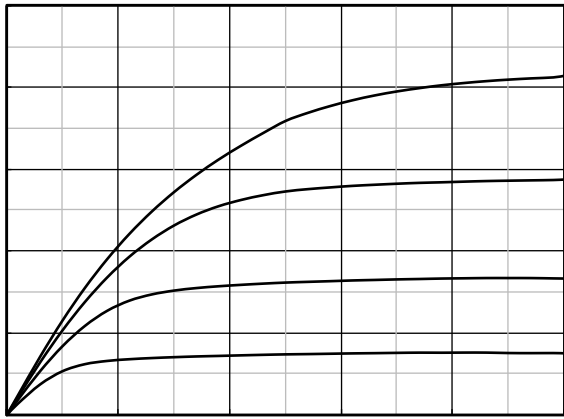

Figure 1. Output Characteristics

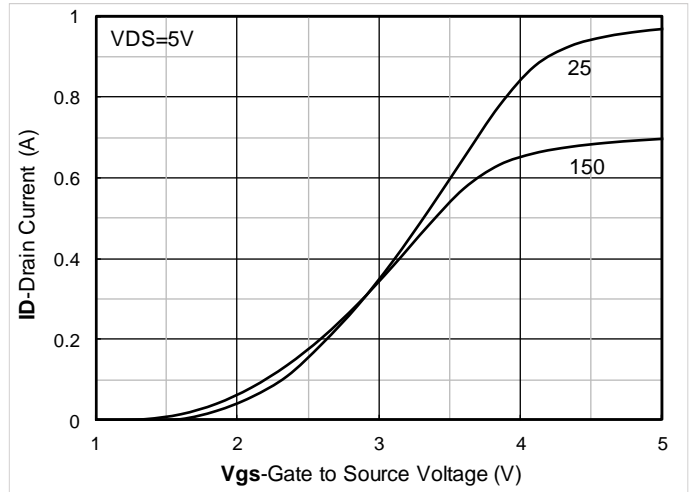

Figure 2. Transfer Characteristics

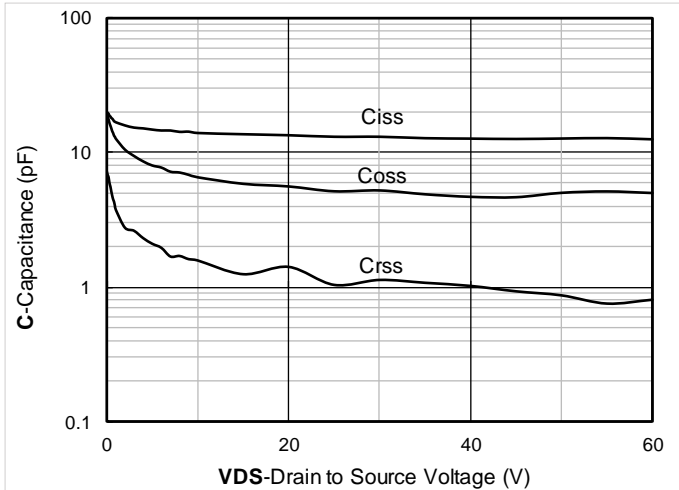

Figure 3. Capacitance Characteristics

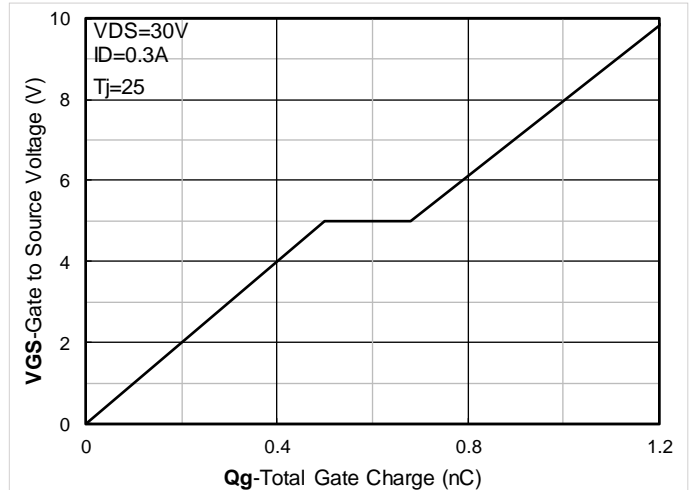

Figure 4. Gate Charge

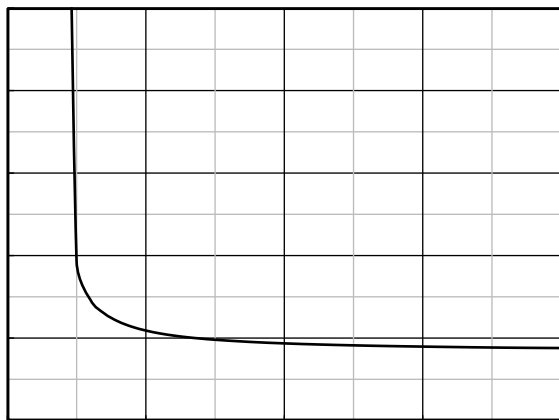

Figure 5. On-Resistance vs Gate to Source Voltage

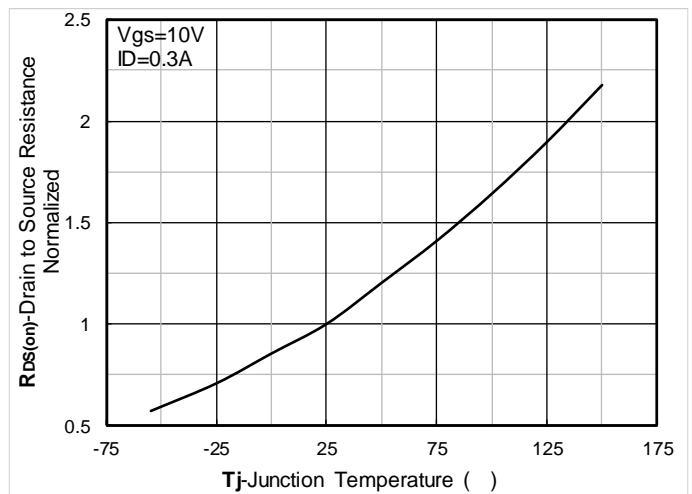

Figure 6. Normalized On-Resistance





Figure B. Gate Charge Test Circuit & Waveform

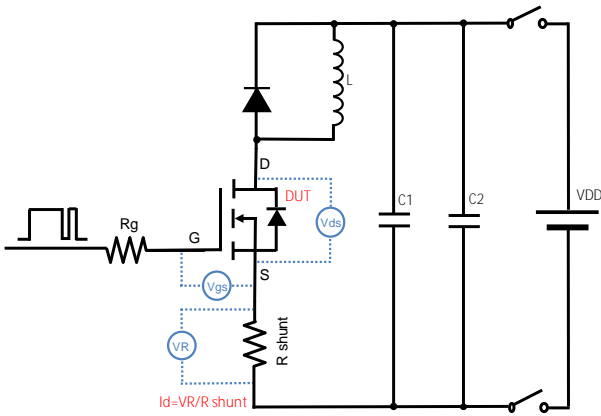

Figure C. Resistive Switching Test Circuit & Waveform

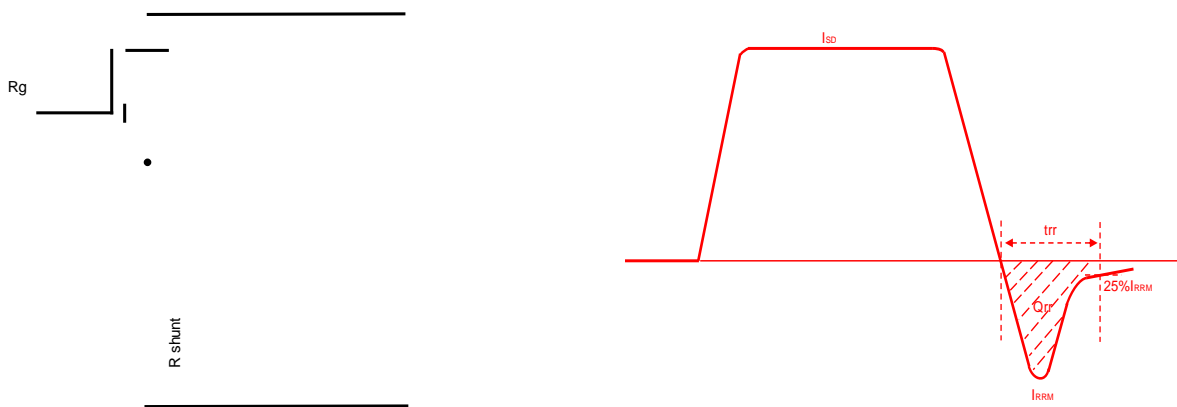

Figure D. Diode Recovery Test Circuit & Waveform



2N7002KCT

SOT-723 Package information

