

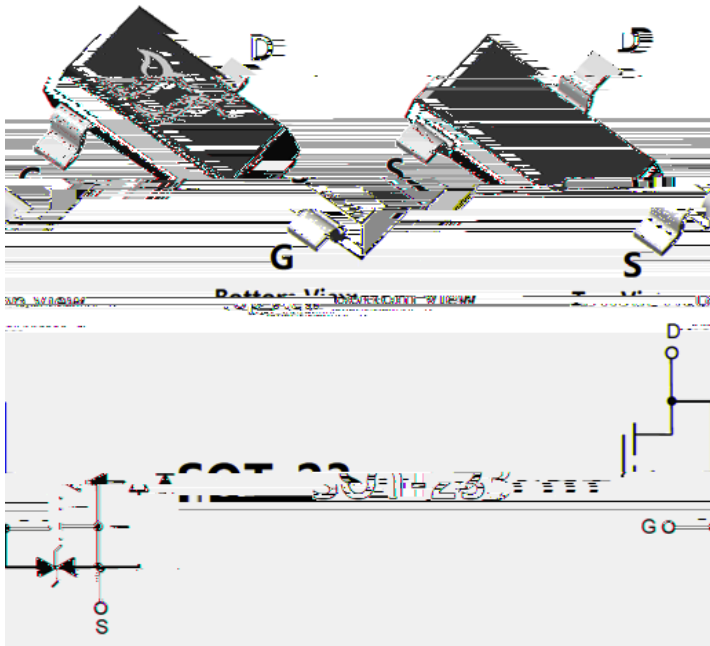

BSS138KJ

N-Channel Enhancement Mode Field Effect Transistor



Product Summary

V_{DS}	60V
I_D	0.6A
$R_{DS(ON)}$ (at $V_{GS}=10V$)	1.5
$R_{DS(ON)}$ (at $V_{GS}=4.5V$)	1.8
$R_{DS(ON)}$ (at $V_{GS}=2.5V$)	3.7
$R_{DS(ON)}$ (at $V_{GS}=1.8V$)	8.5
Gate-Source ESD Rating Up to 2KV (HBM)	

General Description

Trench Power MV MOSFET technology
 Voltage controlled small signal switch
 Low input Capacitance
 Fast Switching Speed
 Moisture Sensitivity Level 1
 Epoxy Meets UL 94 V-0 Flammability Rating
 Halogen Free

Applications

Battery operated systems
 Solid-state relays
 Direct logic-level interface TTL/CMOS

Absolute Maximum Ratings ($T_A=25$ unless otherwise noted)

Parameter		Symbol	Limit	Unit
Drain-source Voltage		V_{DS}	60	V
Gate-source Voltage		V_{GS}	± 20	V
Drain Current	$T_A=25$	I_D	0.6	A
	$T_A=100$		0.38	
Pulsed Drain Current ^A		I_{DM}	1.5	A
Total Power Dissipation ^B	$T_A=25$	P_D	0.8	W
	$T_A=100$		0.3	
Junction and Storage Temperature Range		T_J, T_{STG}	-55 +150	

Thermal resistance

Parameter		Symbol	Typ	Max	Units
Thermal Resistance Junction-to-Ambient ^C	Steady-State	R_{JA}	120	150	$^{\circ}W$

Ordering Information (Example)

PREFERRED P/N	PACKING CODE	Marking	MINIMUM PACKAGE(pcs)	INNER BOX QUANTITY(pcs)	OUTER CARTON QUANTITY(pcs)	DELIVERY MODE
BSS138KJ	F2	BK	3000	30000	120000	7" reel



BSS138KJ

Electrical Characteristics ($T_J=25$ unless otherwise noted)

Parameter	Symbol	Conditions	Min	Typ	Max	Units
Static Parameter						
Drain-Source Breakdown Voltage	BV_{DSS}	$V_{GS}=0V, I_D=250\mu A$	60	-	-	V
Zero Gate Voltage Drain Current	I_{DSS}	$V_{DS}=60V, V_{GS}=0V$ $V_{DS}=60V, V_{GS}=0V, T_J=150$	-	-	1	μA



BSS138KJ

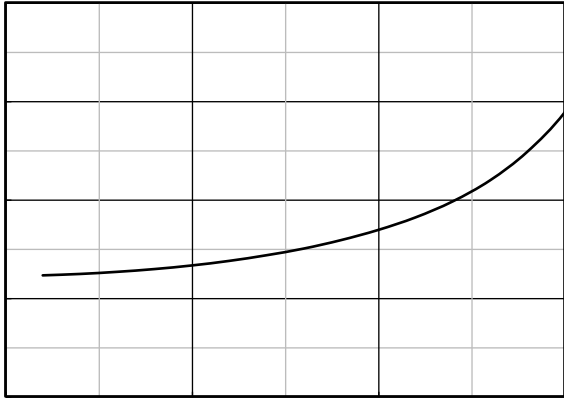

Figure 7. $R_{DS(on)}$ VS Drain Current

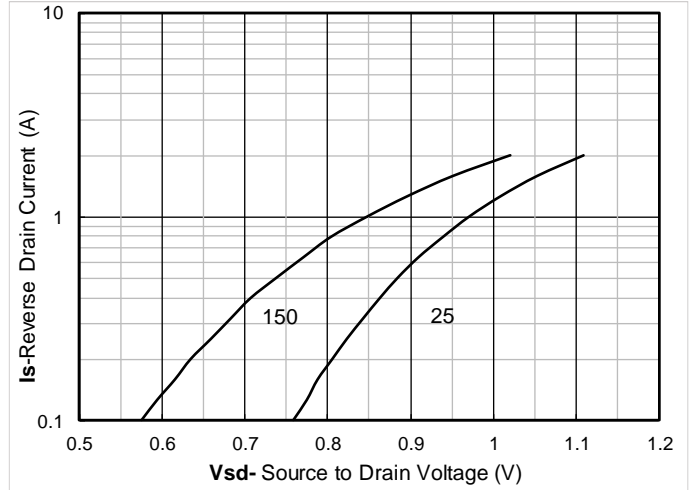

Figure 8. Forward characteristics of reverse diode

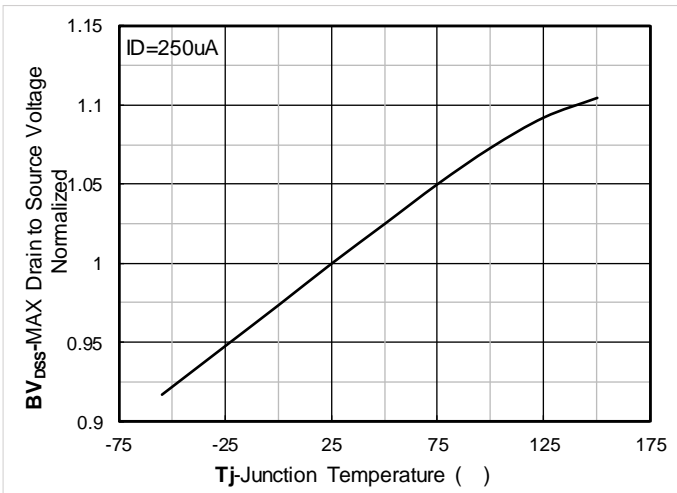

Figure 9. Normalized breakdown voltage

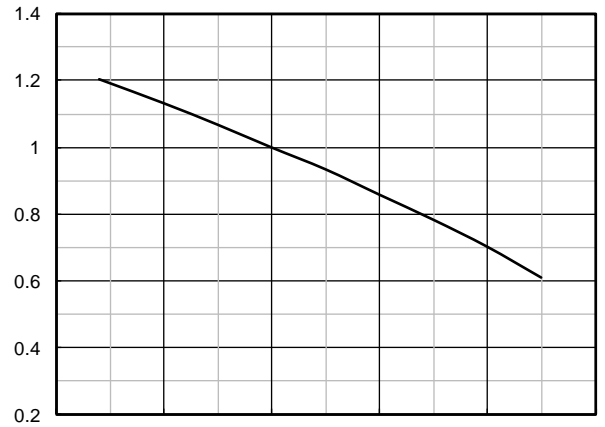

Figure 10. Normalized Threshold voltage

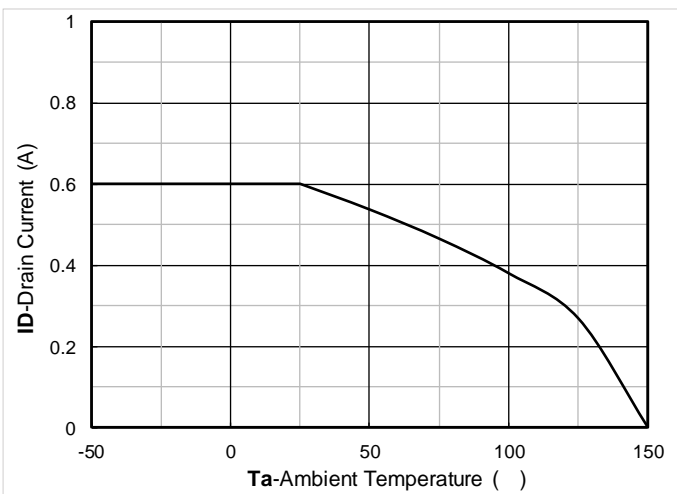

Figure 11. Current dissipation

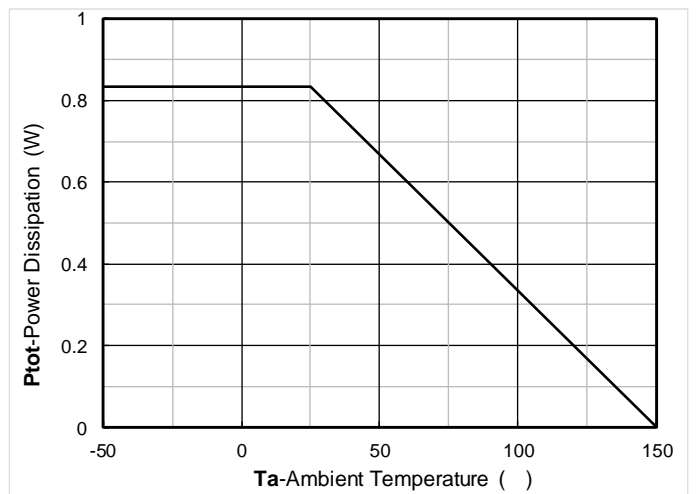

Figure 12. Power dissipation

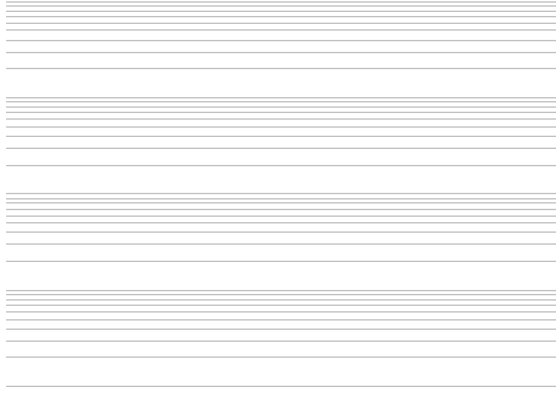

Figure 13. Maximum Transient Thermal Impedance

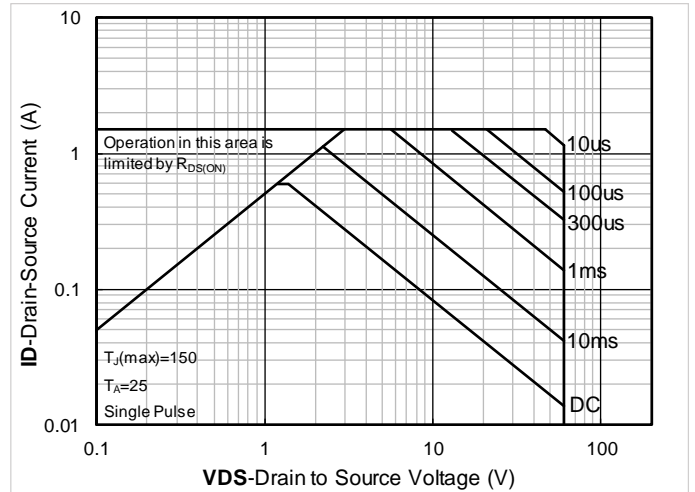

Figure 14. Safe Operation Area

Test Circuits & Waveforms



Figure A. Unclamped Inductive Switching (UIS) Test Circuit & Waveform



Figure B. Gate Charge Test Circuit & Waveform

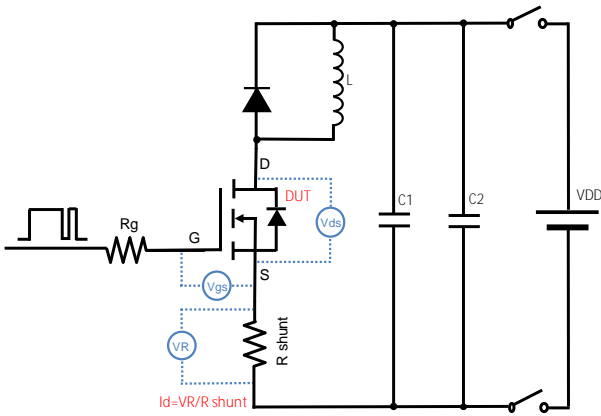

Figure C. Resistive Switching Test Circuit & Waveform

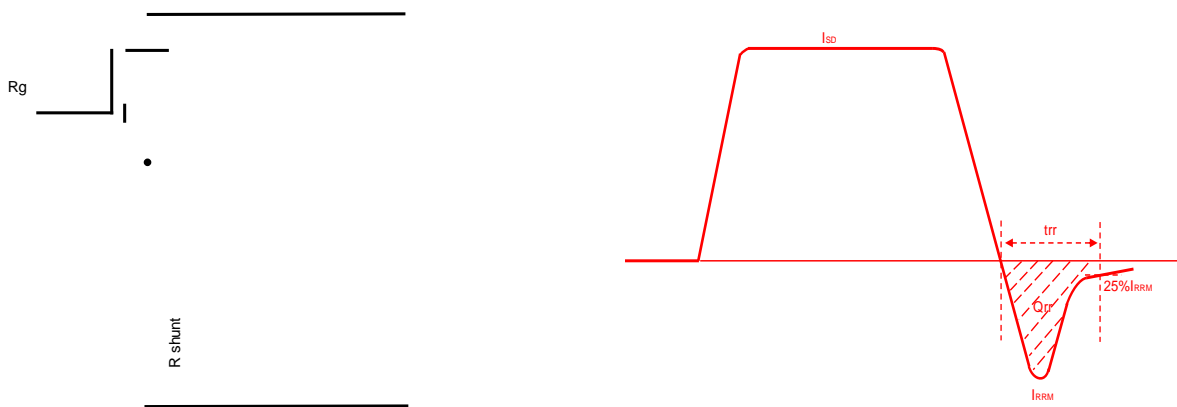
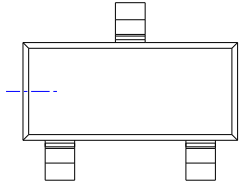

Figure D. Diode Recovery Test Circuit & Waveform



BSS138KJ

SOT-23 Package information



UNIT mm



BSS138KJ

Disclaimer

The information presented in this document is for reference only. Yangzhou Yangjie Electronic Technology Co., Ltd. reserves the right to make changes without notice for the specification of the products displayed herein to improve reliability, function or design or otherwise.

The product listed herein is designed to be used with ordinary electronic equipment or devices, and not designed to be used with equipment or devices which require high level of reliability and the malfunction of which would directly endanger human life (such as medical instruments, transportation equipment, aerospace machinery, nuclear-reactor controllers, fuel controllers and other safety devices), Yangjie or anyone on its behalf, assumes no responsibility or liability for any damages resulting from such improper use of sale.

This publication supersedes & replaces all information previously supplied. For additional information, please visit our website <http://www.21yangjie.com> , or consult your nearest Yangjie's sales office for further assistance.