





YJD80N03A

Electrical Characteristics ($T_J=25$ unless otherwise noted)

Parameter	Symbol	Conditions	Min	Typ	Max	Units
Static Parameter						
Drain-Source Breakdown Voltage	BV_{DSS}	$V_{GS}=0V, I_D=250$	30			V
Zero Gate Voltage Drain Current	I_{DSS}	$V_{DS}=30V, V_{GS}=0V$			1	
		$V_{DS}=30V, V_{GS}=0V, T_J=150$			100	
Gate-Body Leakage Current	I_{GSS}	$V_{GS}=\pm 20V, V_{DS}=0V$			± 100	nA
Gate Threshold Voltage	$V_{GS(th)}$	$V_{DS}=V_{GS}, I_D=250$	1.0	1.5	2.5	V

$V_{GS}=\pm 20V$

Static Drain-Source On-Resistance

$R_{DS(on)}$



Typical Performance Characteristics

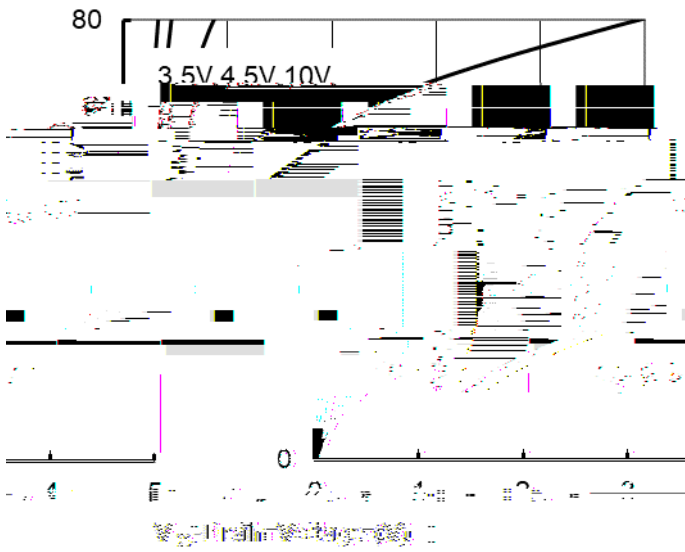

Figure 1. Output Characteristics

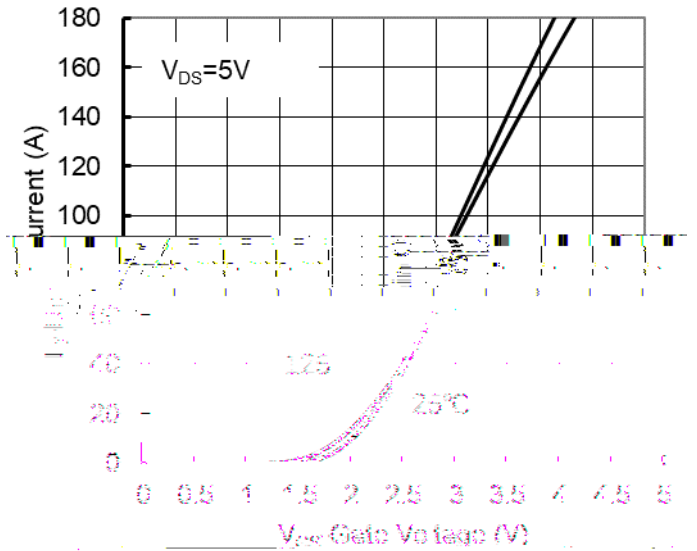

Figure 2. Transfer Characteristics

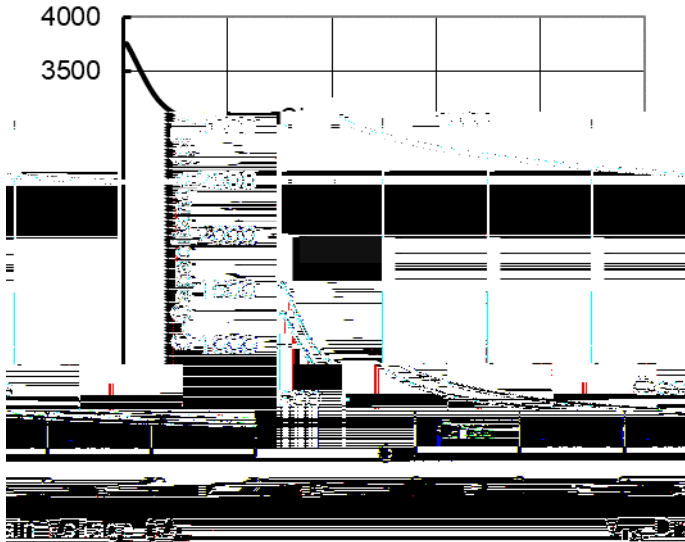

Figure 3. Capacitance Characteristics

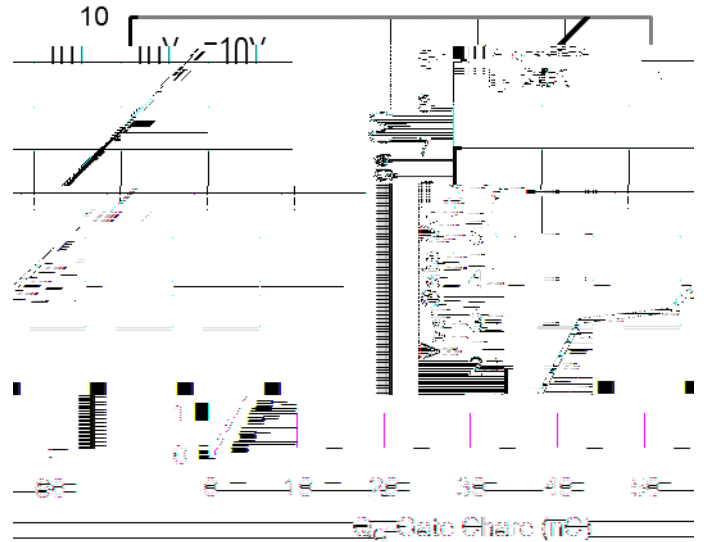
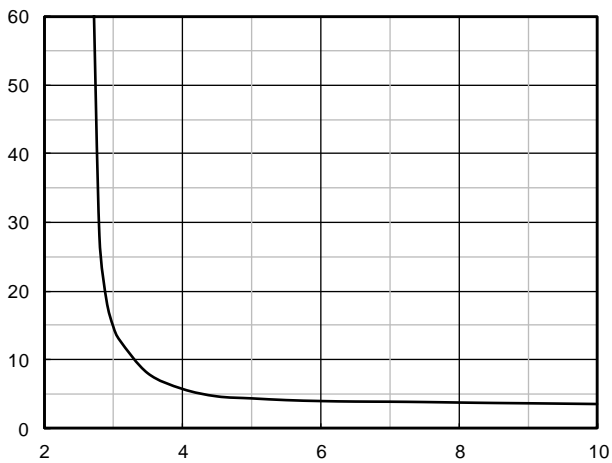

Figure 4. Gate Charge



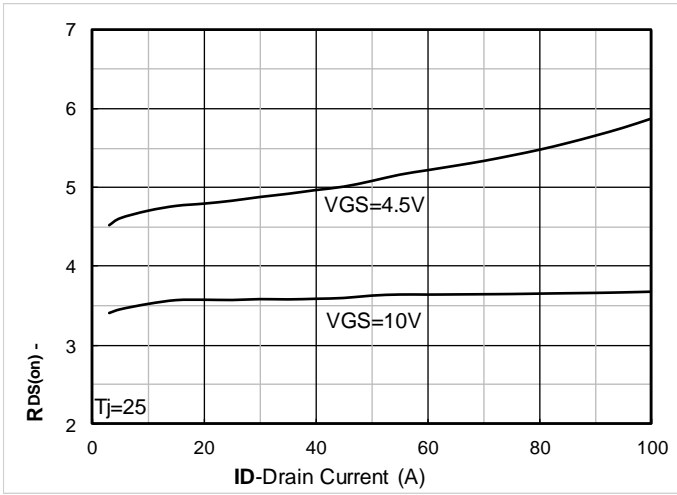

Figure 7. $R_{DS(on)}$ VS Drain Current

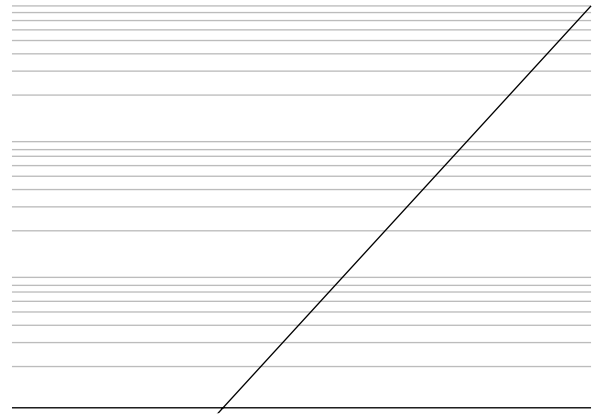

Figure 8. Forward characteristics of reverse diode

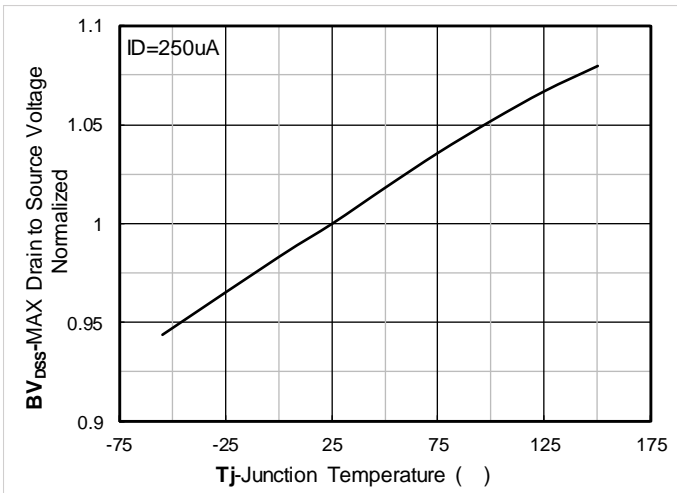

Figure 9. Normalized breakdown voltage

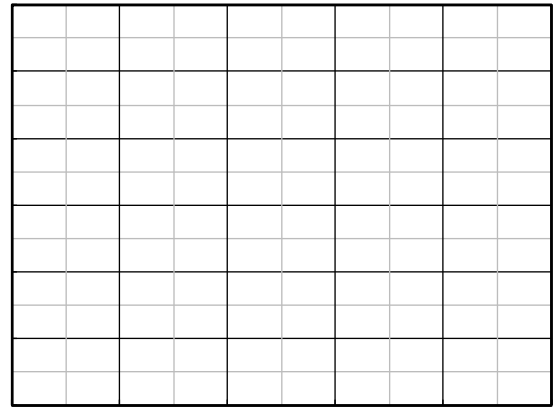

Figure 10. Normalized Threshold voltage

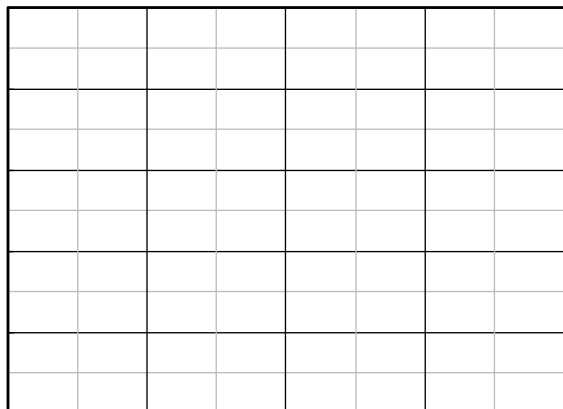
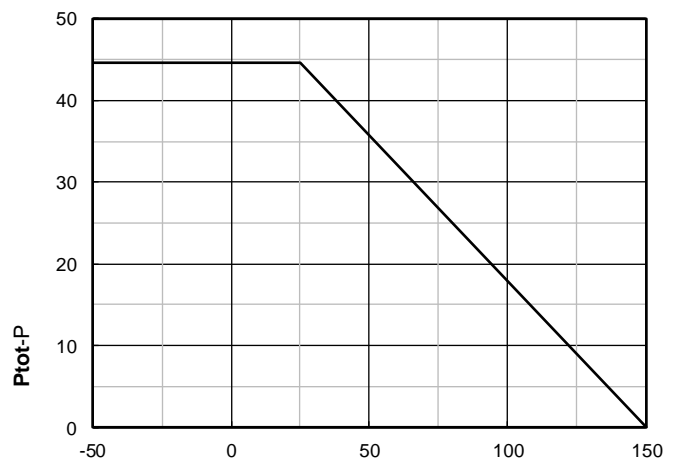

Figure 11. Current dissipation



Figure

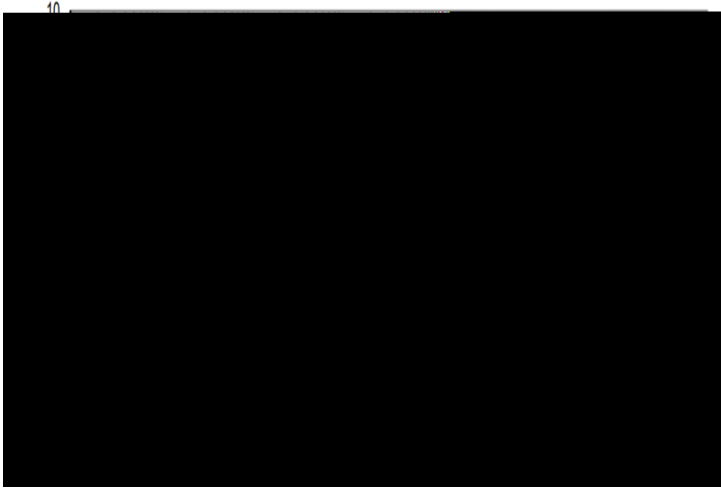

Figure 13. Normalized Maximum Transient Thermal Impedance

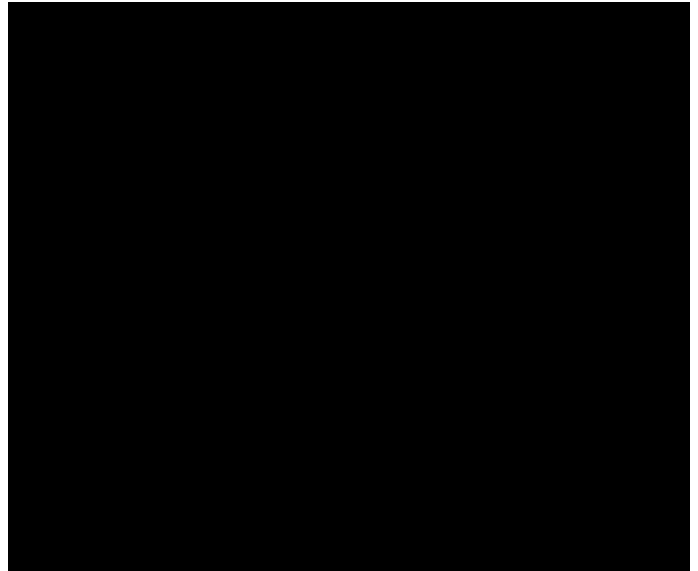
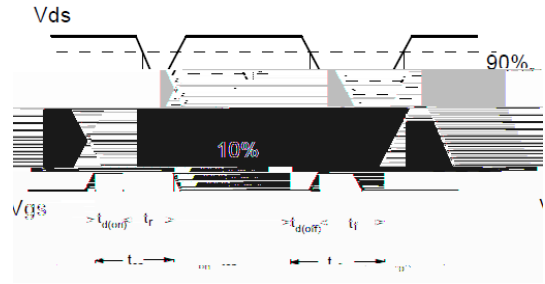
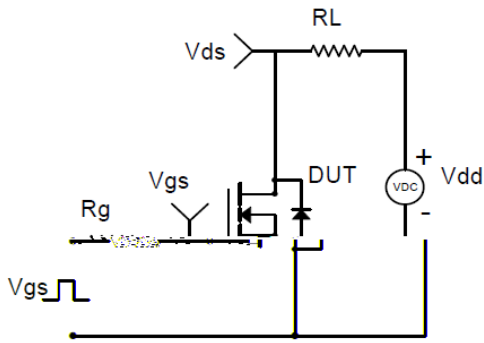
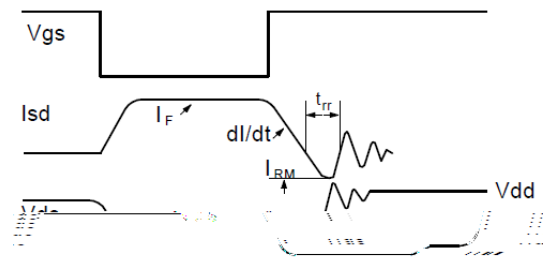
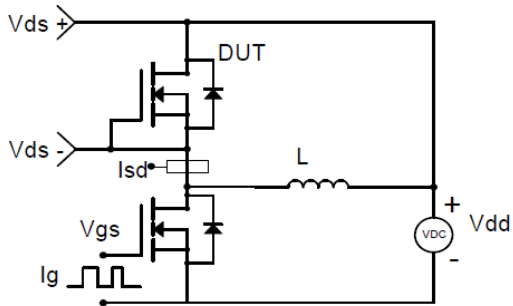

Figure 14. Safe Operation Area



Resistive Switching Test Circuit & Waveforms



Diode Recovery Test Circuit



YJD80N03A

TO-252-B Package information

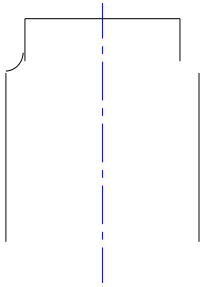
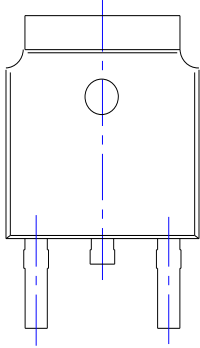

SYMBOL	DIMENSIONS			
	INCHES			
	MIN.	NOM.		
A1	0.000			
A2	0.087	0.091		
A3	0.035	0.039		
b	0.026	0.030		
c	0.018	0.020		
D	0.256	0.260		
D1				
D2	0.181	0.189		
E	0.390	0.398		
E1	0.236	0.240		

NOTE:
1.PACKAGE BODY SIZES EXCLUDE MOLD FLASH AND GATE BURRS.
2.TOLERANCE 0.1mm UNLESS OTHERWISE SPECIFIED.
3.THE PAD LAYOUT IS FOR REFERENCE PURPOSES ONLY.

